

Innovation For Creativity

metal ceilings and facades



MADE IN ITALY
MANUFACTURING
QUALITY • DESIGN



PRODUCT TYPE

600x1200 mm
other dimension on request
Syncro springs panels
Right edge

PANELS MATERIALS

Steel 5/10 | 6/10 | 7/10 | 8/10
Stainless steel 5/10 | 6/10
Aluminium 7/10 | 8/10

HIDDEN STRUCTURE

Syncro Crossing: "C" Syncro beams and spacers with air-tight gasket to apply on site

ANTI-SEISMIC EQUIPMENTS

Antiseismic Kit for:
≤ 1,2 m plenum | > 1,2 m high plenum

HANGERS

Hooking bracket with threaded bar
Suspensions to evaluate according to the load at m², to the project features and antiseismic requirements.

COLOURS AND FINISHING

Standard pre-painted white | silver
RAL / NCS coatings | Plain surface
Sublimation | Digital printing
Antimicrobial treatment (Defence H*)

WALL ANGLES

"Double L" 43x10x15x20 mm profile with "V" spring and air-tight gasket to be applied on site

ACCESSORIES

Custom made integrated lighting by Atena Lux

Product range: HOSPITAL CEILING

SYNCRO XL AIR-TIGHT

SYNCRO CROSSING

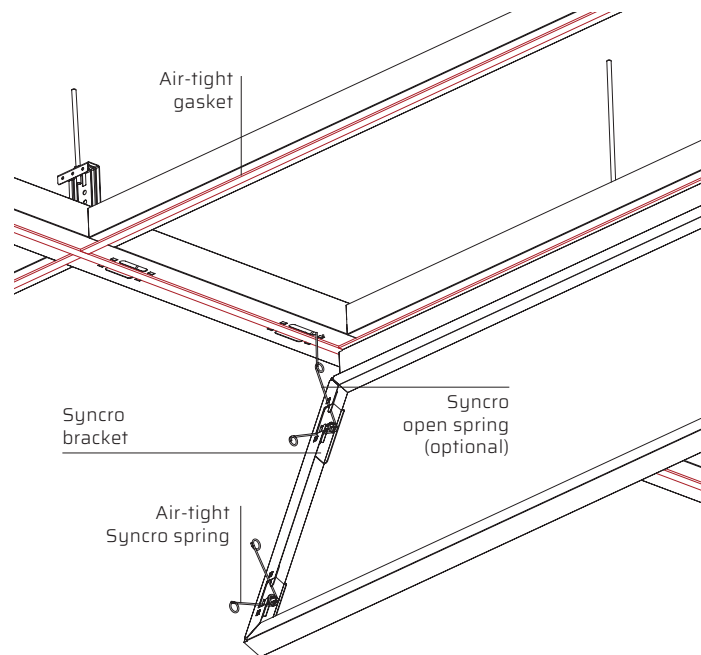
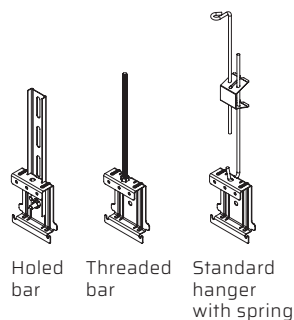
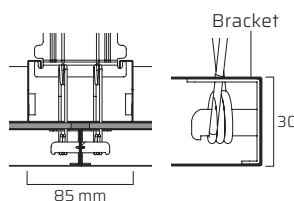
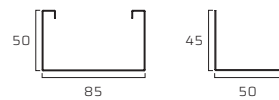

MATERIAL AND WEIGHT

PANEL MATERIAL | METAL CEILING WEIGHT PER Kg/m²

PANEL MATERIAL	PAN.	STR.	U.M.
STEEL 5/10	~5,23	~3,5	kg/m ²
STEEL 6/10	~6,24	~3,5	kg/m ²
STEEL 7/10	~7,24	~3,5	kg/m ²
STEEL 8/10	7,36	~3,5	kg/m ²
STAINLESS STEEL 5/10	~5,28	~3,5	kg/m ²
STAINLESS STEEL 6/10	~6,29	~3,5	kg/m ²
ALUMINIUM 6/10	1,94	~3,5	kg/m ²
ALUMINIUM 8/10	2,58	~3,5	kg/m ²

* Panels' weight springs included.
* Structure weight: beams, spacers, hooking brackets. Hangers and wall angles not included.

*verify **interaxes** and **hanger models** according to the load at m² the antiseismic report and particular conditions. The **fastening** must be checked with regard to the loads, the anchoring base features and the installation accuracy, in order not to compromise the stability of the metal ceiling system. Lightings, accessories and systems must not weigh on the metal ceiling system, but must be independently suspended.

*verify **interaxes** and **hanger models** according to the load at m² the antiseismic report and particular conditions. The **fastening** must be checked with regard to the loads, the anchoring base features and the installation accuracy, in order not to compromise the stability of the metal ceiling system. Lightings, accessories and systems must not weigh on the metal ceiling system, but must be independently suspended.

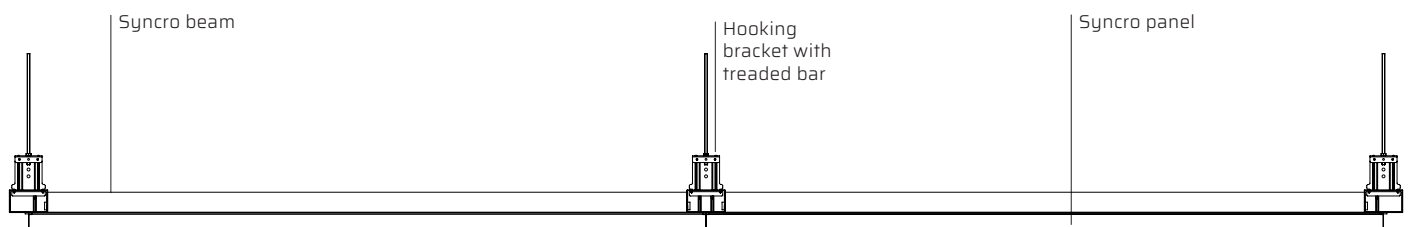
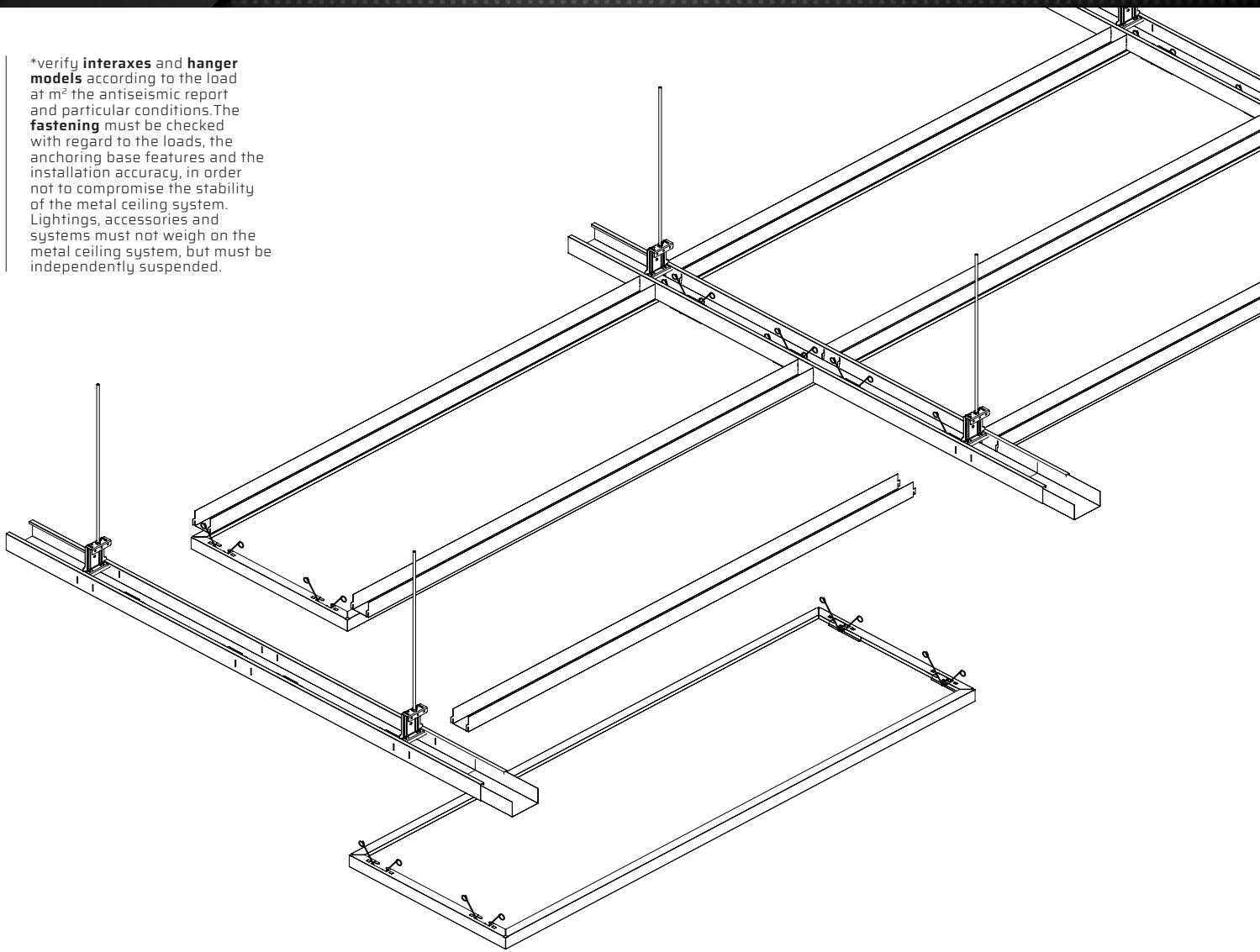

COMPONENT INCIDENCES

ID	DESCRIPTION	INCIDENCE*
1	SYNCR0 PANEL	1,40 pcs/sqm
2	DOUBLE L WALL ANGLE	- pz/sqm
3	HANGERS	1 pcs/sqm
4	V SPRINGS	1 pcs/sqm
5	SYNCR0 BEAM	0,85 lm/sqm
6	SYNCR0 SPACER	1,70 lm/sqm
7	LONGITUDINAL JOINT	0,30 pcs/sqm
8	NEOPRENE GASKET	5 lm/sqm





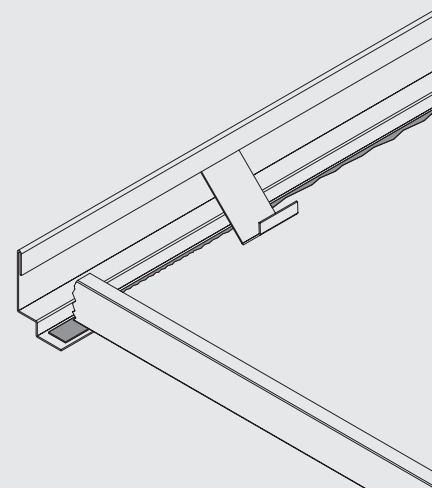
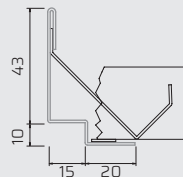





AIR-TIGHT WALL ANGLE

"C" wall angle with air-tight spring and perimeter gasket.







* Component incidences 600x1200mm model

TECHNICAL PERFORMANCES







	FLEXION RESISTANCE	Maximum span mm 1200 - 1 Class EN13964
	CORROSION RESISTANCE	Galvanized steel products: C2 Class Pre-painted galvanized steel products: C3 Class Post-painted galvanized steel products: C4 Class Pre/post-painted aluminium products: C5 Class
	(RH%) RELATIVE HUMIDITY RESISTANCE	Galvanized steel products: ≤ 90% Pre/post-painted galvanized steel products: > 90% Stainless steel and aluminium products: > 90
	COLOR STABILITY	In compliance with technical tolerances standard. Test according to the ΔE - CIELab method. ISO 7724-2 (3)
	FIRE REACTION UNI EN 13501-1	A1 Class
	METAL CEILING MAXIMUM LOAD	12 kg/m ²
	DURABILITY OF OF PAINTED ITEMS	C Class EN13964
	DURABILITY OF GALVANIZED ITEMS	B Class EN13964
	LIGHT REFLECTION	Smooth glossy white: up to 85% ISO 7724-2 (3)
	ACOUSTICS	Information in "Acoustic Performance"

HEALTHCARE

	AIR CLEANLINESS CLASS	ISO 2 ISO 14644-1 Fraunhofer institute Stuttgart		CLEANING ⁽¹⁾	Wet cloth with warm water and neutral non-abrasive detergents. High pressure water.
	RESISTANCE TO MOLD⁽⁴⁾	Products " Defence H* "		DISINFECTION IDONEITY ⁽²⁾	" Defence 4H* " galvanised post-painted steel products only. VDI2083 P.17; ISO 4628-1; ISO2812-1 - Fraunhofer institute - Stuttgart
	ANTIMICROBIAL PROPERTIES⁽³⁾ ISO 22916	Products " Defence 1H* " in galv. pre-painted steel : Products " Defence 2H* " in pre-painted aluminum: Products " Defence 3H* 4H* " in alu. / galv. st. post-paint.:			action > 99% action >99% action >99%

(1): Clean the metal ceiling by dry-cleaning before proceeding with water; the false ceiling can be washed with high pressure water if sealed with silicone.
(2): Value calculated with Easy T24 and Easy Antiseismic T24 structures. (3): Frequent cleaning with diluted disinfectants containing active agents such as formalin, hydrogen peroxide, sulfuric acid, phosphoric acid, hydrochloric acid, isopropanol, sodium hydroxide and sodium hypochlorite. (4): Information on the tested bacterial spectrum available on request. (5): pre-painted and post-painted steel and aluminum products are resistant to mold thanks to their chemical-physical properties. Products maintain the declared performance properties if properly cleaned and maintained.

SUSTAINABILITY

	RELEASE OF DANGEROUS SUBSTANCES*	None CAM 2.4.1.3 EN13964		FORMALDEHYDE*	E1 Class CAM 2.3.5.5
	DISASSEMBLY*	Steel Aluminium 100% recyclable CAM 2.4.1.1		MATERIAL DEMOLITION AND REMOVAL*	Non hazardous waste in compliance with CAM 2.5.1.
	RECYCLED PRODUCT CONTENT*	CAM 2.4.1.8 compliance		GREEN BUILDING	Requirements: LEED (BREEAM and ITACA for cross-section aspects)

* Data declaration as required by the ISO 14021 standard

WARRANTY

The warranty, covers the manufacturing products defects. Except as provided in the specific warranty extensions, the warranty period is one year from delivery of goods. Any complaints must be communicated in accordance with the sales terms and conditions. Metal ceilings system components have been conceived for this purpose only, any other use is considered improper.

CLEANING, MAINTENANCE AND REMOVAL INSTRUCTIONS

Cleaning and maintenance require some attention and care even though are easy to make and don't take much time. It is necessary to use warm water and neutral and non-abrasive detergents. It is recommended to clean the metal ceiling by dry-cleaning before proceeding with water. 24 Syncro Evo and Syncro XL Air-Tight can be washed with high pressure water if sealed with silicone. Metal ceilings made in antimicrobial post painted galvanised steel "Defence H4" tested for chemical resistance by Fraunhofer Institut di Stuggart, can be cleaned frequently with diluted disinfectants containing active agents such as formalin, hydrogen peroxide, sulfuric acid, phosphoric acid, hydrochloric acid, isopropanol, sodium hydroxide and sodium hypochlorite. Metal ceilings maintenance usually refers to: placement, alignment or replacement of damaged or broken modules (panels, staves, baffles, open cells) which can be also removed for restoration or maintenance of the system below. In order to ensure an excellent results, the maintenance work must be carried out by specialised workers trained with technical data sheets about setting, removal and maintenance of the metal ceilings. Using inadequate tools can damage the bearing structure, causing adherence loss or even accidental modules fall. All the maintenance intervention must follow the technical data sheet instructions or specific information when provided and every diversity has to be promptly reported. Each worker charged with maintenance operation must carefully remove the modules, perform the intervention and do not alter the metal ceiling structure, the hanging system and the connection between these elements. When the maintenance is over, modules must be installed again, checking that these are well hooked or positioned if they are lay-in/on on a visible structure and that the flatness of the assembly is guaranteed. Any difference in level is caused by wrong installation and, for this reason, the system must be quickly controlled.

STORAGE MODE

Materials shall be maintained in good condition from purchase to installation. Materials must be stored in a closed, clean and dry site, not under direct light. Materials provided with protective films must be transported and stored in proper environmental conditions, i.e.: temperature 10 to 30°C, relative humidity 40 to 75%RH. Within three (3) months of delivery and in any case before installation, the protective films must be removed. Products are protected with resistant packaging under normal handling. Please handle packages with care to avoid shocks and inappropriate handling that might damage what is provided. The manual handling must be carried out with caution and in compliance with safety regulations at work. For carriage of packaged products on pallets, provide a mechanical transport to avoid damages or risks resulting from inadequate transport.

SUSTANABILITY AND SAFETY

All metal ceilings ITALIAN SELECTION are made with products that do not release dangerous substances into the environment including formaldehyde. Coating and / or sublimation are free from Volatile Organic Compounds (VOC). The products will be recyclable and as a whole manufactured using recycling processes materials, the recycled material percentage is calculated for each type of product, in compliance with CAM requirements and declared according to the ISO 14021 standard. The metal ceiling systems contribute to getting credits for the certification of building design, construction and sustainable and efficient management according to the LEED protocol and to the BREEAM and ITACA cross-cutting aspects.

FASTENERS

IFC supplies the hangers and accessories such as screws, washers and nuts to connect the elements of its own supply only. Lightings, accessories and systems must not weigh on the metal ceiling system, but must be independently suspended. The fastening must be checked with regard to the loads, the anchoring base features and the installation accuracy, in order not to compromise the stability of the metal ceiling system.

ANTISEISMIC EQUIPEMENTS

According to the NTC 2018, when the non-structural element is assembled on site: structure designer is in charge of identifying the request, the supplier and / or installer is in charge of providing elements and connection systems of adequate capacity, the project manager is in charge of verifying the accuracy of installation". Therefore it is necessary to communicate to IFC the stresses acting on the false ceiling (seismic acceleration, wind load,..) in order to allow a proper calculation of the single elements. For more information on IFC's anti-seismic systems, contact the reference sales offices. The documentation on the site is for example only. (NTC 2018 § 7.2.3-7.2.4).

NORMATIVE REQUIREMENTS

IFC LTD is maker and sole distributor in Israel and Palestinian territories.

“Italian selection” products are manufactured in Italy by the selected Italian maker Atena S.p.A.

The Italian company has adopted a quality management system in compliance with the UNI EN ISO 9001 standard.

All “Italian selection” metal ceilings are produced for indoor applications, in compliance with Technical Standards for Construction NTC 2018 and relative circular requirements, the Minimum Environmental Criteria CAM (Ministerial Decree 11 October 2017), the specific technical standards applicable UNI EN 13964 and 14195. Each product has its own DOP (CE Declaration of Performance) according to the European Law for construction products 305/2011.

The performance properties declared in D.o.P. Declarations of Performance provided by the manufacturer are guarantees, if the metal ceilings are installed in the environment conditions for which it has been conceived and the recommended maintenance is executed.

Precisely, metal ceilings are non-structural construction elements therefore they must be properly sized in order to withstand with adequate safety against all actions that can stress the building, such as, but not limited to, earthquakes, winds, thermal expansion, humidity, etc., in relation to the installation site, the building use and the project technical features. Check with IFC technical department the specific environmental conditions to which the product will be subjected, in order to choose the most suitable materials for the installation site.

In the case of outdoor installation, the metal ceilings are not covered by an harmonized technical standard, therefore they are not subject to the regulation 305/2011. They are in any case subjected to the NTC 2018 and to the safety checks of civil constructions, and must be properly sized according to the installation site environmental conditions, to the structural features and to the project specifications.

The products are sold to the customer together with guarantees and technical sheets, with instructions for transport, unloading, storage, handling, installation and maintenance, supplied by the manufacturer, verified and approved by IFC.

Independently by information, suggestions, advices and technical opinions exchanged between the parts, during pre-agreement negotiations IFC will supply the products only according to the orders received and the technical drawings/projects attached, having no responsibility on what is not indicated in the order, in the technical drawings or in the project.

All rights are reserved and subject to industrial protection. All data provided and illustrated are indicative and can be changed at any time according to the business needs and the production processes.

The information contained in this following sheet must to be considered updated at the date of writing. Changes in product performance occurred after that date may affect the accuracy of the data sheet: it is compulsory for users to make sure to have the latest version of this sheet.



Italian selection products



I.F.C. LTD

14, Habana Im. Street P.O. BOX 12384 Ashood

Tel: +972 8 6699111 Fax: +972 8 6699122

ifc.co.il - info@ifc.co.il